

**GQ, GS, GZ, GT, GD, GTF, GFW  
ACCESSORIES**

## HEATSINKS

### DESCRIPTION

Different models of heatsinks have been designed and tested to meet size and dimension needs.

#### How to choose a heatsink

- Set max. air temperature inside the panelboard ( $T_{max_a}$ )
- Set max. operating current:  $I_{max} = I_{nom. load} + 10\%$
- Draw on the "graphs"  $T_{max_a}$ ,  $I_{max}$  points.

- Choose the smallest heatsink (starting from upwards), which point  $[T_{max_a} | I_{max}]$  is in the gray working area of dissipation curves
- Respect installation distances

### INSTALLATION

In order to obtain best reliability, it is important to install a heatsink correctly inside the panel, to reach an adequate thermal exchange between the device and the surrounding air in natural convection conditions.

#### How to install it correctly:

Mount it vertically ( max. 10° inclination from the vertical axis)

- Vertical distance between a heatsink and the panel wall: 100 mm at least.
- Horizontal distance between a heatsink and the panel wall: 20 mm at least.
- Vertical distance between two heatsinks: 300 mm at least.
- Horizontal distance between two heatsinks: 40 mm at least.

Check that cable channels do not reduce these distances; should it happen, mount the relays overhanging from the panel, so that the air can flow vertically on the heatsink without obstacles (see Fig.1).

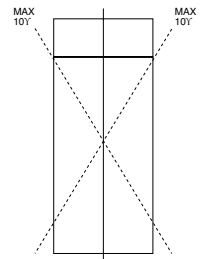
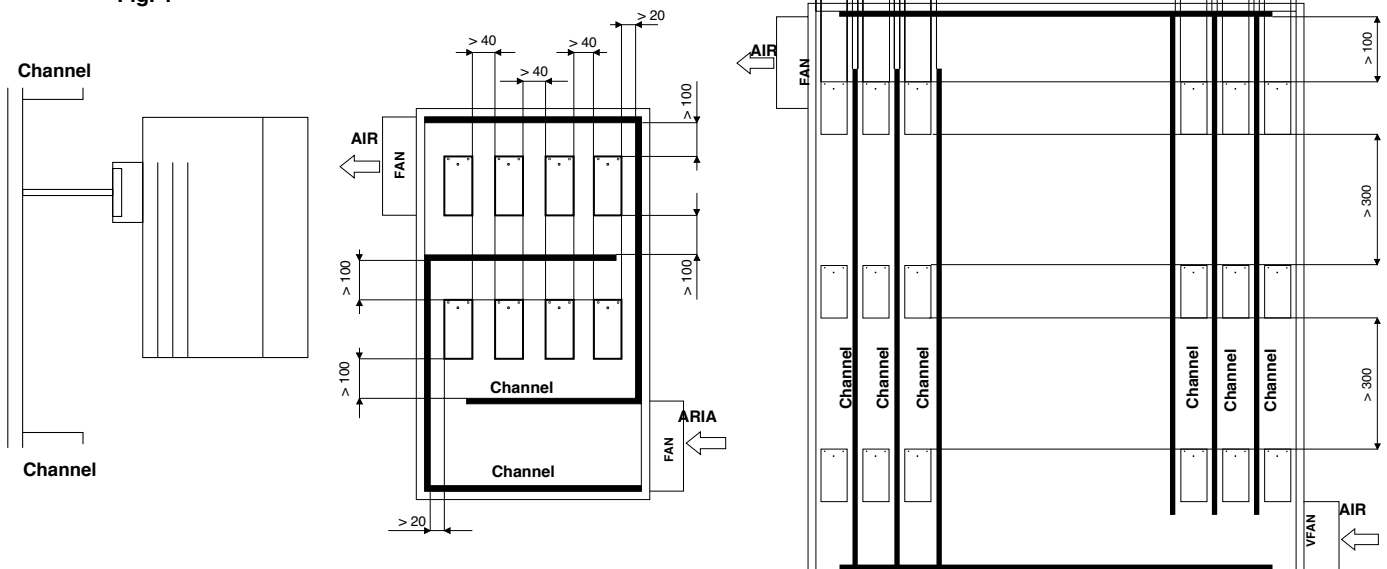

Fig. 1



# DISSIPATION CURVES

Effective current controllable based on room temperature

DIS 15G

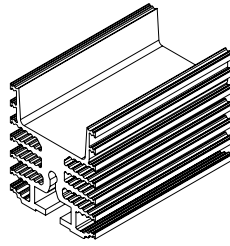
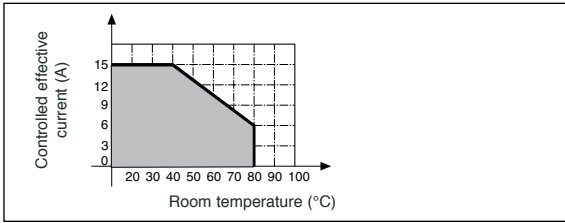

h = 57mm  
 $R_{th} = 4,1^{\circ}\text{C/W}$   
 (\*)

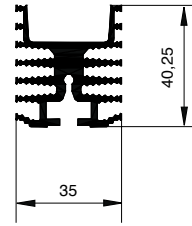

DIS 25G

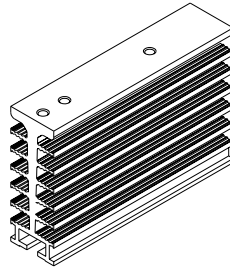
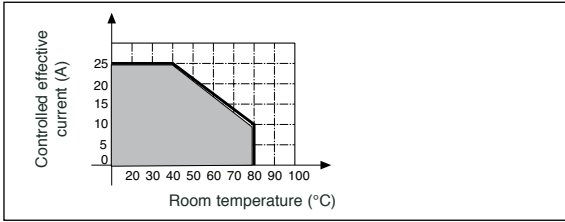

h = 100mm  
 $R_{th} = 3,12^{\circ}\text{C/W}$   
 (\*)

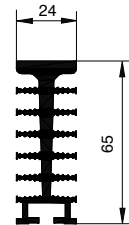

DIS 25GD

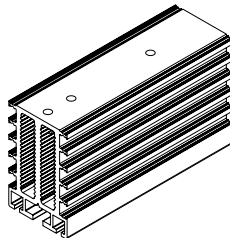
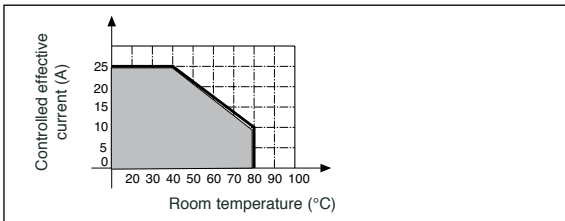

h = 100mm  
 $R_{th} = 2,8^{\circ}\text{C/W}$   
 (\*)

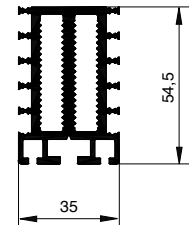

DIS 40G

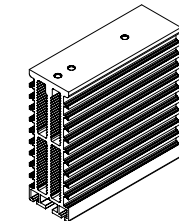
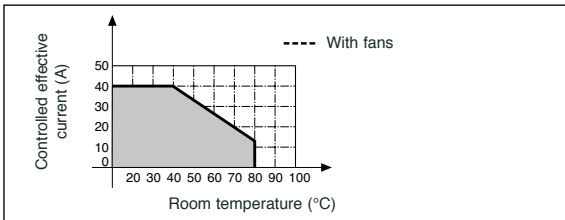

h = 100mm  
 $R_{th} = 1,90^{\circ}\text{C/W}$   
 (\*)

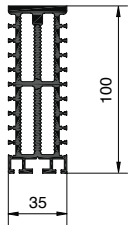

DIS 50G

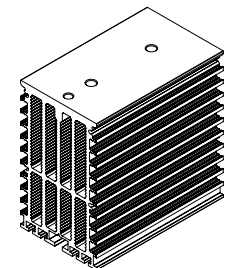
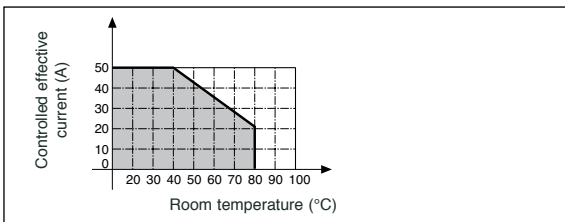

h = 100mm  
 $R_{th} = 0,83^{\circ}\text{C/W}$   
 (\*)

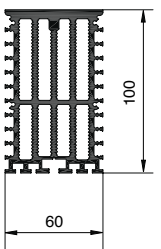

DIS 60G

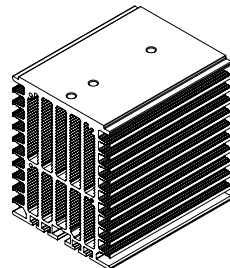
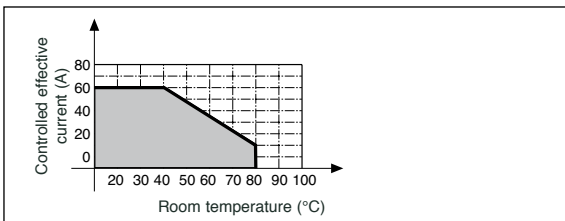

h = 100mm  
 $R_{th} = 0,66^{\circ}\text{C/W}$   
 (\*)

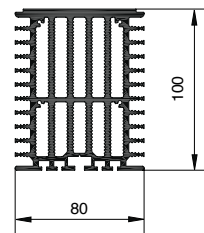

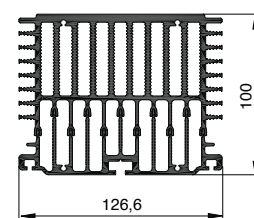
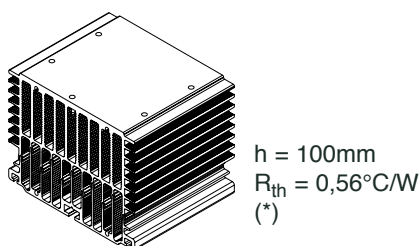
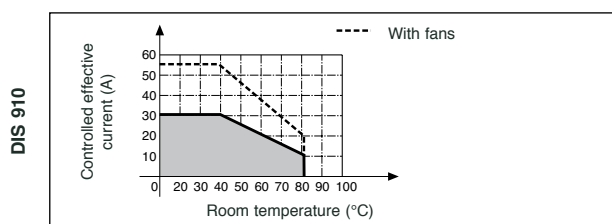
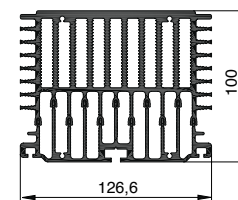
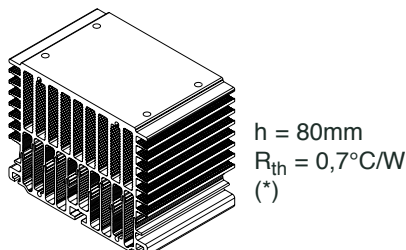
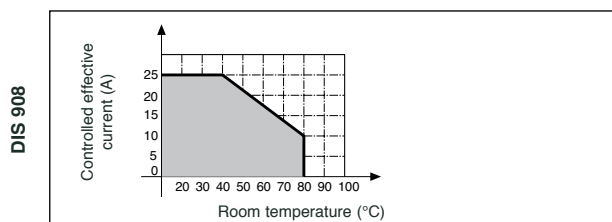
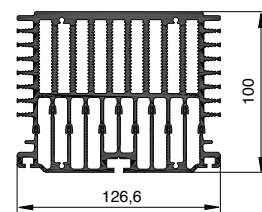
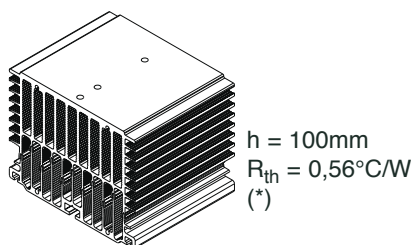
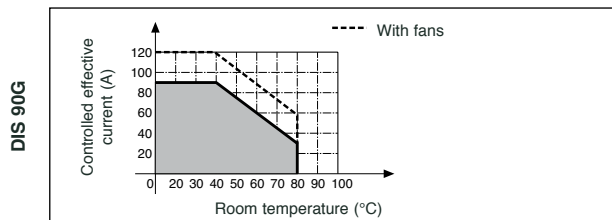

Should the stated point  $[T_{max_a} I_{max}]$  be outside the working area, it is necessary to equip the heatsink with a fan and a safety thermostat.

**N.B.** The operating point has not to be outside the delimited area.

- DIS908/910 heatsinks are suitable for three-phase solid state relays of GZ series.

- Controlled three-phase effective current refers to the used line current of three-phase load.

- Heatsinks used with a cooling fan should be equipped with safety thermostat, so that the solid state relay can be switched off in case of fan failure.

(\*) Data surveyed with 40°C ambient temperature and heatsink in vertical position surrounded by 15 cm free space; natural convection; contact surface with the heating element =  $\sim 8\text{cm}^2$  [38mmx 20mm]

### HEAT SINKS - ORDER CODE - AVAILABLE MODELS

CODE	DESCRIPTION (dimensions HxLxP)	for SSR type	equipment
DIS-25G	heatsink in extruded aluminium 100x24x65	GS 15/25A	M4 screws for relay fixing DIN rail mounting
DIS-25GD	heatsink in extruded aluminium 100x35x54	GS $\leq$ 40A / GD	M4 screws for relay fixing DIN rail mounting
DIS-40G	heatsink in extruded aluminium 100x35x100	GS $\leq$ 40A / GD40A	M4 screws for relay fixing DIN rail mounting
DIS-50G	heatsink in extruded aluminium 100x60x100	GS $\leq$ 50A / GT / GQ	M5 screws for relay fixing DIN rail mounting
DIS-60G	heatsink in extruded aluminium 100x80x100	GS $\leq$ 50A / GT / GQ	
DIS-90G	heatsink in extruded aluminium 100x126x100	GS $\leq$ 50A / GT / GQ	
DIS-908	heatsink in extruded aluminium 80x126x100	GZ	
DIS-910	heatsink in extruded aluminium 100x126x100	GZ	
DIS-25G-1M	heatsink in extruded aluminium for group mounting SSR, with DIS-25G profile		
DIS-40G-1M	heatsink in extruded aluminium for group mounting SSR, with DIS-40G profile		
DIS-50G-1M	heatsink in extruded aluminium for group mounting SSR, with DIS-50G profile		
DIS-60G-1M	heatsink in extruded aluminium for group mounting SSR, with DIS-60G profile		
DIS-90G-1M	heatsink in extruded aluminium for group mounting SSR, with DIS-90G profile		

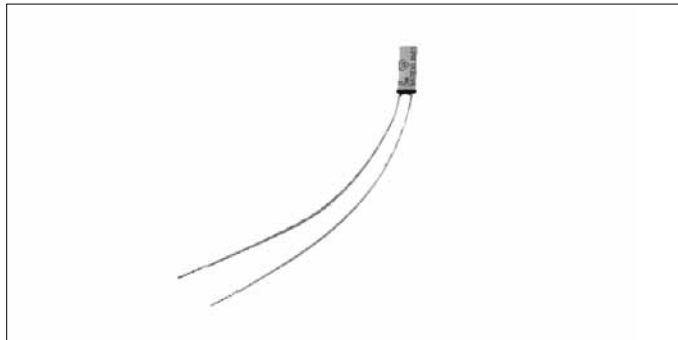

## POWER SOLID STATE RELAYS ACCESSORIES

### THERMOSTAT

#### DESCRIPTION

Safety thermostat is expressly designed to prevent overtemperature.

Thanks to the miniaturized case the thermal answer is excellent. Furtheron, the thermostat is a very good thermal protection, as it can be mounted very near to the critical point which has to be controlled.

When it is connected in series to control voltage, the thermostat disenergises the relay as soon as the critical operating temperature is reached. Relay is energised again when temperature drops underneath the critical value (about 90°C).

The thermostat is normally closed and opens when temperature exceeds 90°C (with automatic reset). Connection in series with the input control is suggested. TGRZ is installed in one of the two slots of the GZ three-phase solid state relay case.

TGR is fixed by means of a small bracket and of a screw (enclosed).

The VIR-1 thermostat is supplied as a spare part for: W21x  $\geq$  150A solid state power units.

#### INSTALLATION

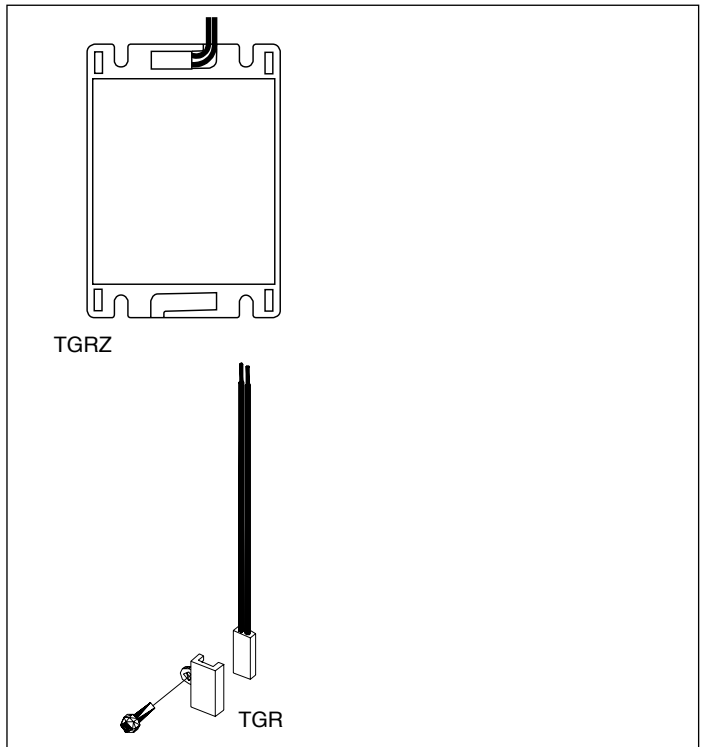

#### ORDER CODE - AVAILABLE MODELS

T-GR (includes fastening bracket)

T-GRZ (for GZ)

VIR-1 (for W21x  $\geq$  150A)

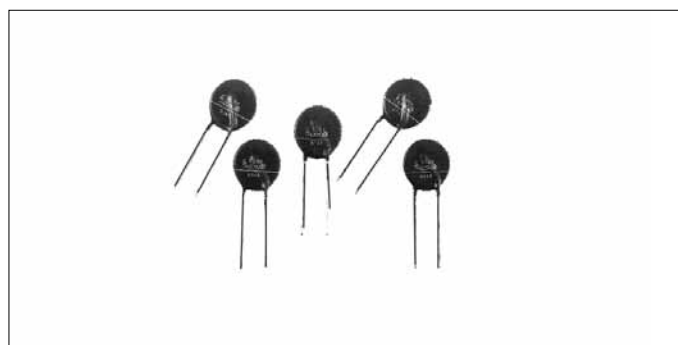

## SOLID STATE RELAY ACCESSORIES

### VARISTORS (MOV)

#### Spark Suppressors for Solid State Relay Protection

#### DESCRIPTION

MOV (metal-oxide-varistor) is an overvoltage protection device which improves the reliability of solid state relays when functioning

ORDER CODE	WORKING VOLTAGE (V)
RV03	120-290 Vac
RV04	291-400 Vac
RV05	401-500 Vac



## HEATSINKS ACCESSORIES

### FANS

#### DESCRIPTION

An additional fan, applied to the heatsink of a solid state relay, improves its dissipation performance and allows the solid state relay to work at higher ambient temperatures with the same current. Fan installation benefits are shown (dashed) by the dissipation curves of the different heatsinks.

#### ORDER CODE - AVAILABLE MODELS

Code	Description	Mechanical predisposition for heatsink type	Equipment	For SSR type
VEN-60	Fan kit 24Vdc, 4W 60x60x25	DIS-50G DIS-60G	hand guard nr. 4 screws nr. 4 plastic fastening rivets for direct attachment to heatsink	
VEN-90	Fan kit 230Vac, 14W, 50Hz 80x80x40	DIS-90G DIS-910 DIS-908	hand guard nr. 4 M4 screws nr. 4 notched washers nr. 4 plastic fastening rivets for direct attachment to heatsink	GTS 120A GTT 120A GTZ $\geq$ 40A
VEN-91	Fan kit 115Vac, 14W, 50Hz 80x80x40	DIS-90G DIS-910 DIS-908	hand guard nr. 4 M4 screws nr. 4 notched washers nr. 4 plastic fastening rivets for direct attachment to heatsink	GTS 120A GTT 120A GTZ $\geq$ 40A
VEN-92	Fan kit 24Vdc, 4W 80x80x25	DIS-90G DIS-910	hand guard nr. 4 M4 screws nr. 4 notched washers nr. 4 plastic fastening rivets for direct attachment to heatsink	GTS 120A GTT 120A GTZ $\geq$ 40A

## ACCESSORIES GTF / GFW

#### ORDER CODE - AVAILABLE MODELS

Code	Description	Mechanical predisposition for heatsink type	Equipment	For SSR type
VEN-60	Fan kit 24Vdc, 4W 60x60x25	DIS-60G	hand guard D60 nr. 4 screws M2 + notched washers nr. 4 plastic fastening rivets cable with ferrules	GTF40, 50 EI.Fuse
VEN-62	Fan 24Vdc, 4W, 60x60	To be included in the grid GRI-4	cable wit 3 pole connector	GTF150 GFW40,60,100,150
VEN-63	Fan 24Vdc, 4W 60x60	To be included in the grid GRI-4	cable wit 3 pole connector	GTF200, 250 GFW200,250
VEN-92	Fan kit 24Vdc, 4W 80x80x25	DIS-90G	hand guard D80 nr. 4 M4 screws + notched washers nr. 4 plastic fastening rivets cable with ferrules	GTS 120A GTF60 EI.Fuse
GRI-4	Fan grill			GTF150,200, 250 GFW150,200,250
FLT-4	Filtre for fan			GTF150,200, 250 GFW150,200,250

**ACCESSORIES**  
**SUPPORT FOR DIN BAR**

**PANEL ATTACHMENT SUPPORT**

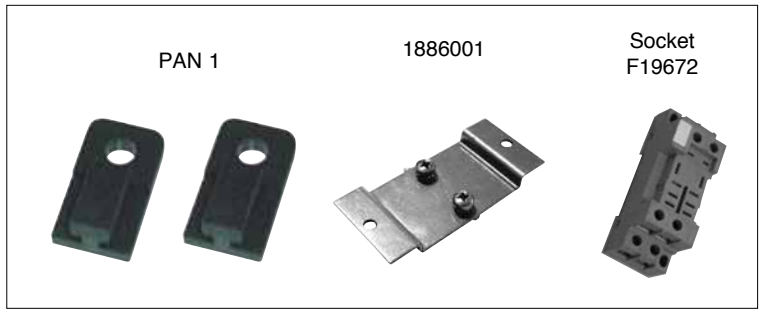
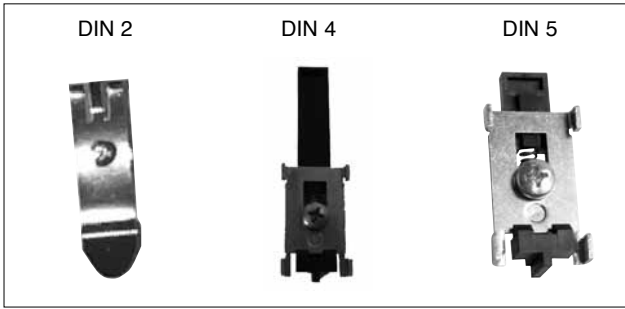

**ORDER CODE - AVAILABLE MODELS**

Code	Description	For SSR / Heatsink type	Equipment
DIN-2	support for attachment to DIN bar	GTS 15/25A DIS15G, DIS25G	fastening screws
DIN-4	support for attachment to DIN bar with spring	W211 25/40/75/100/150A W212 25/40/75/100/150A	fastening screws
DIN-5	support for attachment to DIN bar with spring	GTS, GTD, GTT, GTZ, DIS15G, DIS25GD, DIS25G, DIS40G, DIS50G, DIS60G, DIS90G, DIS908, DIS910	fastening screws
F19672	socket for relays with attachment to DIN bar	GTS-L 5/10/15A	fastening screws
PAN-1	kit attachment to panel	GTS, GTT,	nr. 2 plastic supports nr. 2 screws nr. 4 washers
1886001	kit attachment to panel	Wattcor series	



**SOLID STATE RELAY  
ACCESSORIES**

**COVERS FOR SOLID STATE RELAYS**

**ORDER CODE - AVAILABLE MODELS**

Code	Description
COP-GS-0	Pad-printed cover for GS-T 10A, 20A and GS 15A, 25A.
COP-GS-1	Pad-printed cover for GS-T 25A and GS40A.
COP-GS-2	Pad-printed cover for GS 50A, GS 60A, GS 75A, GS 90A, GS 120A.
COP-GD-0	Pad-printed cover for GD40.
COP-GTS-0	Pad-printed cover for GTS-T 10A, 20A and GTS 15A, 25A.
COP-GTS-1	Pad-printed cover for GTS-T 25A and GTS 40A.
COP-GTS-2	Pad-printed cover for GTS 50A, 60A, 75A, 90A, 120A.
COP-GTD-0	Pad-printed cover for GTD-25
COP-GTD-1	Pad-printed cover for GTD-40
COP-GT-0	Pad-printed cover for GT 25A, 40A, 50A, 60A, 75A, 90A, 120A.
COP-GTT-0	Pad-printed cover for GTT 25A, 40A, 50A, 60A, 75A, 90A, 120A.
COP-GTS-L-0	Cover for GTS-L5
COP-GTS-L-1	Cover for GTS-L10 / GTS-L15
BBR	Protective cover for RA single-phase solid state relays



## SOLID STATE RELAY ACCESSORIES

### FUSES AND FUSE HOLDERS

#### DESCRIPTION

These fuses ensure the maximum safety in solid state relay applications.  
Fuses with a very high cutoff power are used for this kind of applications.

#### MODEL SELECTION

**GS-L / GTS-L / GTS-T / GTS / GS / GS-T / GTD / GTT (single-phase with antiparallel thyristor or Triac)**

			FUSES AND FUSE HOLDERS					
Type relay	i <sup>2</sup> t	Nominal voltage	Size	Dimensions (mm)	Fuse order code	Fuse holder order code	Notes	
GS-L5 / GTS-L5 / GTS-L4-5	45	230 440	5A	10x38	FUS-06-L	PF-10x38	plug-in	
GS-L10 / GTS-L10 / GTS-L4-10	100	230 440	10A	10x38	FUS-10-L	PF-10x38	plug-in	
GS-L15 / GTS-L15 / GTS-L4-15	180	230 440	15A	10x38	FUS-16-L	PF-10x38	plug-in	
GS-T 10 / GTS-T 10	72	230	10A	10x38	FUS-010	PF-10x38	plug-in	
GS-T 20 / GTS-T 20	315	230	25A	10x38	FUS-025	PF-10x38	plug-in	
GS-T 25 / GTS-T 25	315	230	25A	10x38	FUS-025	PF-10x38	plug-in	

**GQ / GS-L / GTS-L / GTS-T / GTS / GS / GTD / GTT / GTF (single-phase with antiparallel thyristor or Triac)**

			FUSES AND FUSE HOLDERS					
Type relay	i <sup>2</sup> t	Nominal voltage	Size	Dimensions (mm)	Fuse order code	Fuse holder order code (*)	Notes	
GQ / GTS / GS 15	450	230 480	16A	10x38	FUS-016	PF-10x38	plug-in	
GTS / GS / GTT / GQ / GT / GTD 25 GTF25	645 450	230 480 600	25A	10x38	FUS-025	PF-10x38	plug-in	
GTS / GS / GTT / GT / GTD 40	1010	230 480	40A	14x51	FUS-040	PF-14x51	plug-in	
GTF40 / GTF50	1800	480 600	50A	22x58	FUS-050	PF-22x58	plug-in	
GTS / GS / GTT / GQ / GT 50 GTF60	6600	230 480 600	63A	22x58	FUS-063	PF-22x58	plug-in	
GTS / GS / GTT / GT 60 GTF75	6600	230 480 600	80A	22x58	FUS-080	PF-22x58	plug-in	
GTS / GS / GTT / GT 75	8000	230 480	80A	22x58	FUS-080	PF-22x58	plug-in	
GTS / GS / GTT / GQ / GT 90	11200	230 480 600	100A	22x58	FUS-100	PF-22x58	plug-in	
GTS / GS / GTT / GT 120 GTF90 / GTF120	11200	230 480 600	125A	0-0-0-TN/80 100x51x30	FUS-125N	337092- UR400A@1000V PF-DIN	no plug-in	

(\*) **PF** for fuseholders: LEGRAND, **PFI** for fuseholders: ITALWEBER

**MODEL SELECTION****GTZ, GZ (three-phase with antiparallel thyristor)**

Relay	i <sup>2</sup> t	Nominal voltage	FUSE EXTRARAPID / FUSE HOLDER				
			Size	Dimensions (mm)	Fuse order code	Fuse holder order code	Notes
GZ 10A	100	400	10A	10x38	FUS-10-L	PF-10x38	plug-in
GTZ, GZ 25A	450 645	400 480	25A	12x32	FUS-025	PF-10x38	plug-in
GTZ, GZ 40A	1010	480 600	40A	14x51	FUS-040	PF-14x51	plug-in
GTZ, GZ 55A	6600	480 600	63A	22x58	FUS-063	PF-22x58	plug-in

**W21X / W312 / W401 (single-phase with antiparallel thyristor)**

Relay	i <sup>2</sup> t	Nominal voltage	FUSE EXTRARAPID / FUSE HOLDER				
			Size	Dimensions (mm)	Fuse order code	Fuse holder order code	Notes
W21x / W312 25A	1800	660	50A	22x58	FUS-050	in the product	plug-in
W21x / W312 40A	11200	660	63A	22x58	FUS-063	in the product	plug-in
W21x 75A	14450	660	100A	22x58	FUS-100	in the product	plug-in
W21x 100A	86200	660	250A	27x60	FUS-250	in the product	plug-in
W21x 150A	86200	660	250A	27x60	FUS-250	in the product	plug-in
W21x 250A	200000	660	450A	-	FUS-450N	-	no plug-in
W21x 400A	1125000	660	630A	-	FUS-630N	-	no plug-in
W21x 600A	1125000	660	900A	-	FUS-900N	-	no plug-in
W401 40A	11200	460	63A	22x58	FUS-063	in the product	plug-in
W401 100A	86200	460	250A	27x60	FUS-250	in the product	plug-in

**GTF >120 / GFW (with antiparallel thyristor)**

Relay	i <sup>2</sup> t	Nominal voltage	FUSE EXTRARAPID / FUSE HOLDER				
			Size	Dimensions (mm)	Fuse order code	Fuse holder order code	Notes
GFW40	10000	480 600	80A	SI 000 DIN80 100x39x20	FUS-080 S	in the product	plug-in
GFW60	12000	480 600	125A	SI 000 DIN80 100x39x20	FUS-125 S	in the product	plug-in
GFW100	18000	480 600	160A	SI 000 DIN80 100x39x20	FUS-160 S	in the product	plug-in
GTF150 GFW150	125000	480 600	200A	SI 000 DIN80 100x39x20	FUS-200 S	in the product	plug-in
GTF200 GFW200	320000	480 600	450A	SI 000 DIN80 100x65x30	FUS-450 S	in the product	plug-in
GTF250 GFW250	320000	480 600	450A	SI 000 DIN80 100x65x30	FUS-450 S	in the product	plug-in



**ORDER CODE - AVAILABLE MODELS**

FUSES			FUSEHOLDERS (*)
FUS-06-L	FUS-050	FUS-900N	PF 10x38
FUS-010-L	FUS-063	FUS-080S	PF 14x51
FUS-016-L	FUS-080	FUS-125S	PF 22x58
FUS-010	FUS-100	FUS-160S	PF DIN (100x51x30)
FUS-016	FUS-125N	FUS-200S	
FUS-025	FUS-250	FUS-400S	
FUS-030	FUS-450N	FUS-450S	
FUS-040	FUS-630N		

(\*) **PF** for LEGRAND fuseholders, **PFI** for ITALWEBER fuseholders

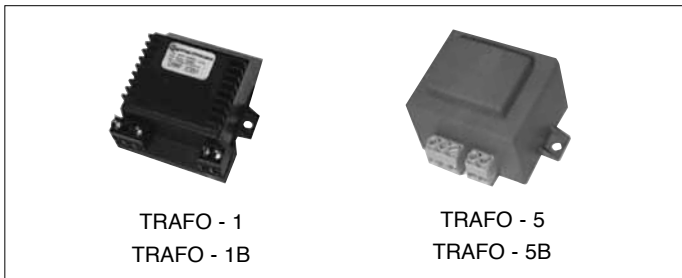

**• Power transformer and isolation**

Transformer for galvanic isolation of power supply.

Dimensions TRAFO - 1 / TRAFO - 1B      L: 58mm    B: 47mm    H: 36mm

Dimensions TRAFO - 5 / TRAFO - 5B      L: 67mm    B: 52mm    H: 45mm

*Order code*

- TRAFO - 1: 3VA transformer, 230/24Vac
- TRAFO - 1B: 3VA transformer, 24/24Vac
- TRAFO - 5: 10VA transformer, 230/24Vac
- TRAFO - 5B: 10VA transformer, 24/24Vac

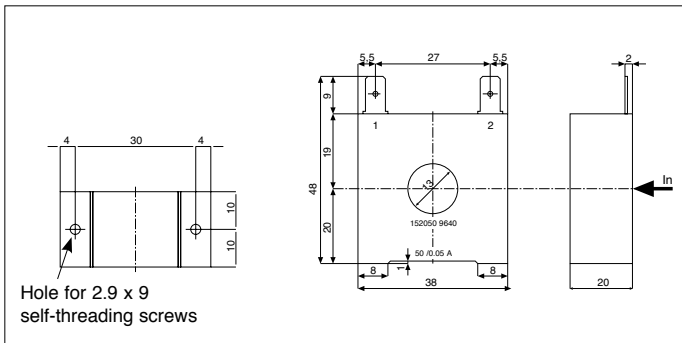

**• Current transformer**

These transformers are used for currents of 50/60 Hz. The main characteristic of these transformers is the high number of turns in the secondary. This provides a very low secondary current, suitable for an electronic measurement circuit. The secondary current can be measured as a voltage on a resistor.

*Order code*

- 330200    IN = 50Aac      OUT = 50mAac
- 330201    IN = 25Aac      OUT = 50mAac

• **Ground terminal for heat sinks**

The ground terminals attached to GEFTRAN heat sinks allow connection of the ground terminal with the screws supplied in the kit.

Type	Ground terminal Contact area (WxD) * Screw type	Screw type on heat sink side	Heat sink
TERM-25	9x12 M5	M4	DIS-25G
TERM-40	11,5x12 M5	M4	DIS-40G DIS-25GD
TERM-60	14x16 M5	M5	DIS-50G DIS-60G DIS-90G

\* (WxD) = Width (mm) x Depth (mm)

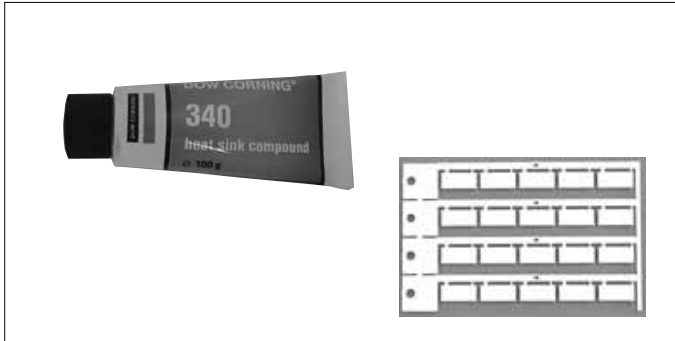

**SOLID STATE RELAYS  
ACCESSORIES**

**THERMOCONDUCTIVE PASTE**

**THERMOCONDUCTIVE ADHESIVES**

**IDENTIFICATION LABELS**

**ORDER CODE**

Code	Description
SIL-1	Silicone thermoconductive paste for coupling the power module to the heat sink. 100 g tube.
SIL-GQ	Graphite film 35x55mm for solid state relays GQ series. Thickness 0,12mm. 2,1W (m*K). 200x240mm sheet with n° 25 adhesives.
SIL-GS40	Graphite film 20x55mm for solid state relays GS ≤ 40A series. Thickness 0,12mm. 2,1W (m*K). 200x240mm sheet with n° 45 adhesives.
SIL-GS50	Graphite film 30x56mm for solid state relays GS ≥ 50A series. Thickness 0,12mm. 2,1W (m*K). 200x240mm sheet with n° 30 adhesives.
LAB-1	Kit with 20 plastic identification labels for GS / GS-T / GTS / GTS-T / GTT / GT / GD / GTD power solid state relays

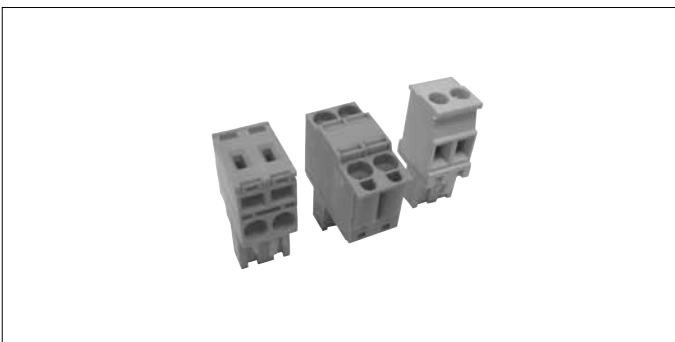

**SOLID STATE RELAYS  
ACCESSORIES**

**CONNECTORS**

**ORDER CODE**

Code	Description
MORS1	Two-pin spring connector, plug-in, for GQ control signal
MORS2	Two-pin double spring connector, plug-in, for GQ control signal
MORS3	Two-pin screw connector, plug-in, for GQ control signal

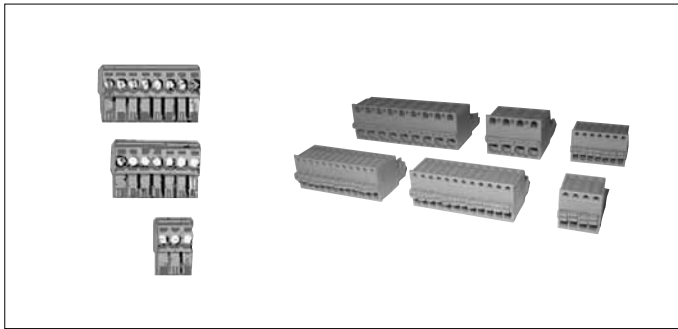

## CONNECTORS FOR INPUTS / OUTPUTS

### GTF and GFW

#### PRODUCT DESCRIPTION

Series of connectors for Geflex inputs/outputs/power supply

#### ORDER CODE

##### Available for GTF25-120A

9-pin connector for power and control (J1)

**COUT4-9**

##### Available for GTF>120A

4-pin connector for outputs (J1)

**COUT4-4**

3-pin connector for power supply (J2)

**CSIG4-3**

4-pin connector for digital input (J3)

**CSIG4-4**

4-pin connector for analog input (J4)

**COUT4-4**

2-pin connector for line voltage (J8)

**CSIG2**

##### Available for GFW

9-pin connector for alarm outputs and cooling (J1)

**COUT4-9**

3-pin connector for power supply (J2)

**CSIG4-3**

4-pin connector for digital input (J3)

**CSIG4-4**

4-pin connector for analog input (J4)

**CSIG4-8**

4-pin connector for analog input control (J5)

**COUT4-4**

4-pin connector for analog input main (J6)

**COUT4-4**

2-pin connector for fan power (J7)

**CSIG4-2**

2-pin connector for line voltage (J10)

**CSIG2**

CONFIGURATION KIT



Configuration kit for standard GTF (via the TTL port) by means of PC with RS232 serial line (Windows environment).

Lets you read or write all of the parameters of a single GTF

A single software for all models

- Easy and rapid configuration
- Saving and management of parameter recipes
- On-line trend and saving of historical data

*Component Kit:*

- Connection cable PC RS232 <-> GTF port TTL
- CD SW GF Express installation

**ORDER CODE**

GF\_eXK-0-0-0.....Cod. F043956



Kit for GFW and GTF configuration with Modbus RS485 serial option by PC / PLC equipped with RS232 serial (Windows environment).

Lets you read or write all of the parameters of a single GTF / GFW

A single software for all models

- Easy and rapid configuration
- Saving and management of parameter recipes
- On-line trend and saving of historical data

*Component Kit:*

- Connection cable PC RS232 <-> GTF / GFW RS485 port
- Serial line converter
- CD SW GF Express installation

**ORDER CODE**

GF\_eXK-1-1-0.....Cod. F043957



kit for PC via the USB port (Windows environment) for GTF standard configuration (TTL port) for configuration of GFW and GTF with the RS485 option

Lets you read or write all of the parameters of a single GTF/GFW

A single software for all models

- Easy and rapid configuration
- Saving and management of parameter recipes
- On-line trend and saving of historical data

*Component Kit:*

- Connection cable PC USB<-> GTF TTL port
- Connection cablePC USB<-> GTF/GFW RS485 serial port
- Serial line converter
- CD SW GF Express installation

**ORDER CODE**

GF\_eXK-2-0-0.....Cod. F049095



The human/machine interface (HMI) is simple, intuitive, and very practical thanks to the optional GFW – OP programming keyboard.

Lets you read or write all of the parameters of a single GFW-M module.

Connected with 9-pin D-SUB connector and housed in the front panel of the GFW-M by means of a magnetic plate.

- Alphameric display: 5 lines x 21 characters.
- Keys to display variable and set parameters.
- Magnetic housing

**ORDER CODE**

GFW - OP.....Cod. F051664

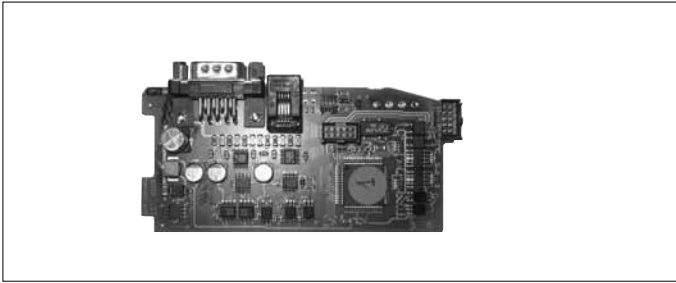

## FIELD BUS CARD

### ORDER CODE

<i>Cards for Modbus RTU protocol</i>	<b>GFX4-MOD</b>
<i>Cards for Profibus DP protocol</i>	<b>GFX4-PROFI</b>
<i>Cards for CANopen protocol</i>	<b>GFX4-CAN</b>
<i>Cards for DeviceNet protocol</i>	<b>GFX4-DNET</b>
<i>Cards for Ethernet Modbus TCP protocol</i>	<b>GFX4-ETH</b>
<i>Cards for Ethernet IP protocol</i>	<b>GFX4-ETH1</b>
<i>Cards for EtherCAT protocol</i>	<b>GFX4-ETH2</b>
<i>Cards for Profinet protocol</i>	<b>GFX4-ETH4</b>
<i>Cards for Real Time Ethernet protocol</i>	<b>GFX4-ETH5</b>



## COMMUNICATION CONNECTORS / ADAPTERS

### PRODUCT DESCRIPTION

Series of connectors for all field bus types (Modbus, Profibus, CANopen, DeviceNet), to facilitate wiring of the communication cable.

Adapters to bring 9 pin SUB connector to front.

### ORDER CODE

<i>Connector for Geflex Master Modbus with cover and inside terminals</i>	<b>CON-M-90</b>
<i>Connector for Geflex Master Profibus with cover and inside terminals</i>	<b>CON-P-90</b>
<i>Connector for Geflex CANopen with cover and inside terminals</i>	<b>CON-C-90</b>
<i>Connector for DeviceNet with cover and inside terminals</i>	<b>CSIG-5</b>
<i>Connector for serial1 (local bus) type 4p4c/RJ10</i>	<b>CRJ10</b>
<i>90° adapter for 9 pin SUBD male connector (Geflex Master CANopen)</i>	<b>AD-9M</b>
<i>90° adapter for 9 pin SUBD female connector (Geflex Master Modbus/Profibus)</i>	<b>AD-9F</b>

## CABLES



### PRODUCT DESCRIPTION

Series of cables for field bus and to extend connections between Geflex GFXS1/S2.

### ORDER CODE

Shielded cable, 1 pair, 22 AWG, L = 1 m Modbus type	<b>2x0,35 CABLE</b>
Shielded cable, 1 pair, 22 AWG, L = 1 m Profibus type	<b>PROFIBUS CABLE</b>
Shielded cable, 2 pairs, 22 AWG, L = 1 m CANopen type	<b>CANBUS CABLE</b>
4-pin telephone cable	<b>CV4-RJ10</b>
Cavo l = 0,3m per collegamento seriale Modbus (RJ10) (bus locale) GFX4 <---> GFX4 e GTF/GFW <---> GTF/GFW	<b>CV4-03</b>
Cable l = 0.3 m for Modbus serial connection (RJ10) (local bus) GFX4 <---> GFX4 and GTF/GFW <---> GTF/GFW	<b>CV4-1</b>
Cable l = 1 m for Modbus serial connection (RJ10) (local bus) GFX4 <---> GFX4 and GTF/GFW <---> GTF/GFW	<b>CV4-2</b>
Cable l = 5 m for Modbus serial connection (RJ10) (local bus) GFX4 <---> GFX4 and GTF/GFW <---> GTF/GFW	<b>CV4-5</b>